

MK item/Interchange News

Date : JULY 6, 2016
No. 16-07

JULY NEW Item Information

As for the MK No. * marks, we have more OE No. information.
Please e-mail to the following address If you want to know the more information.
[e-mail address : mki@mkg.co.jp](mailto:mki@mkg.co.jp)

In another way to find OE No. please use the Product Search in the MK Kashiya web page.
<http://www.mkg.co.jp/global/en/product/search-by-part-number.html>

BRAKE PAD

| MK No. | Application | Releasing Month (accepting order) | Quotation Month |
|--|--|--------------------------------------|--------------------|
| D6108H * Made in Indonesia FMSI NO. D866 FMSI NO. D1285 | MITSUBISHI GALANT EA3A 00.03- | JULY. 2016 | JULY. 2016 |
| | MITSUBISHI ASX GA2W,GA3W 00.03- | | |
| | MITSUBISHI LANCER CS1A,CS3A 00.12-11.03 | | |
| | MITSUBISHI LANCER SPORTBACK CX2A,CX3A 08.07- | | |
| | MITSUBISHI OUTLANDER CW5W 06.11- | | |
| | MITSUBISHI SPACE RUNNER N63W,N64W 99.05-02.08 MITSUBISHI ECLIPSE D53A 99.05-05.02 | | |
| D11217MH Made in Indonesia | SsangYong REXTON 3.2i E32 02.02- | JULY. 2016 | JULY. 2016 |

BRAKE SHOE







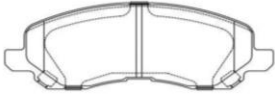
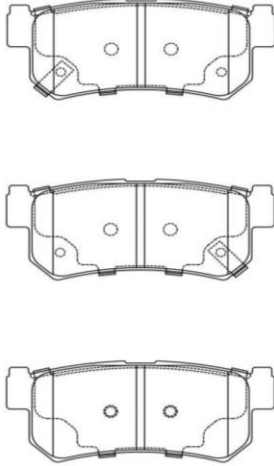



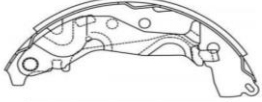

| MK No. | Application | Releasing Month (accepting order) | Quotation Month |
|----------------------------|--|--------------------------------------|--------------------|
| K2421 Made in Japan | TOYOTA YARIS NCP93 13.06-14.04 | JULY. 2016 | JULY. 2016 |
| | TOYOTA COROLLA AXIO NZE161R 13.06-14.04 | | |
| K2423 Made in Japan | TOYOTA COROLLA AXIO NZE161R 14.04- | JULY. 2016 | JULY. 2016 |
| | TOYOTA PRIUS C NHP10L 14.04- | | |
| | TOYOTA SCION xD ZSP110 14.04- | | |
| | TOYOTA RACTIS NCP120 14.04- | | |
| K2425 Made in Japan | TOYOTA ALLION • PREMIO NZT260, ZRT260 13.06- | JULY. 2016 | JULY. 2016 |
| | | | |
| K9000 Made in Indonesia | SUZUKI APV GC415V | JULY. 2016 | JULY. 2016 |
| | SUZUKI CARRY • SUPER CARRY GC415V, GC416V | | |

JULY NEW Item Drawing Information

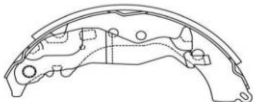
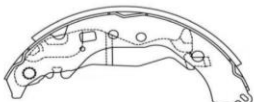
BRAKE PAD

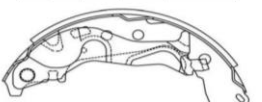
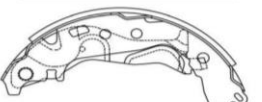
| | | | | | | | |
|--|----------|---------|---------|--|---------|---------|---------|
|  <table border="1" style="margin: auto;"> <tr> <td>X: 145.0</td> <td>Y: 47.5</td> <td>Z: 16.3</td> </tr> </table> <div style="text-align: right; border: 1px solid black; padding: 2px;">D6108H</div> | X: 145.0 | Y: 47.5 | Z: 16.3 |  <table border="1" style="margin: auto;"> <tr> <td>X: 98.7</td> <td>Y: 37.8</td> <td>Z: 15.3</td> </tr> </table> <div style="text-align: right; border: 1px solid black; padding: 2px;">D11217MH</div> | X: 98.7 | Y: 37.8 | Z: 15.3 |
| X: 145.0 | Y: 47.5 | Z: 16.3 | | | | | |
| X: 98.7 | Y: 37.8 | Z: 15.3 | | | | | |

BRAKE SHOE

|  <table border="1" style="margin: auto;"> <tr><th>a</th><th>b</th><th>c</th><th>R</th><th>Shoe Only No.</th></tr> <tr><td>2.9</td><td>1.6</td><td>30.0</td><td>100.0</td><td>M2383</td></tr> </table>  <table border="1" style="margin: auto;"> <tr><th>a</th><th>b</th><th>c</th><th>R</th><th>Shoe Only No.</th></tr> <tr><td>2.9</td><td>1.6</td><td>30.0</td><td>100.0</td><td>M2384</td></tr> </table>  <table border="1" style="margin: auto;"> <tr><th>a</th><th>b</th><th>c</th><th>R</th><th>Shoe Only No.</th></tr> <tr><td>2.9</td><td>1.6</td><td>30.0</td><td>100.0</td><td>M2421</td></tr> </table>  <table border="1" style="margin: auto;"> <tr><th>a</th><th>b</th><th>c</th><th>R</th><th>Shoe Only No.</th></tr> <tr><td>2.9</td><td>1.6</td><td>30.0</td><td>100.0</td><td>M2422</td></tr> </table> <div style="text-align: right; border: 1px solid black; padding: 2px;">K2421</div> | a | b | c | R | Shoe Only No. | 2.9 | 1.6 | 30.0 | 100.0 | M2383 | a | b | c | R | Shoe Only No. | 2.9 | 1.6 | 30.0 | 100.0 | M2384 | a | b | c | R | Shoe Only No. | 2.9 | 1.6 | 30.0 | 100.0 | M2421 | a | b | c | R | Shoe Only No. | 2.9 | 1.6 | 30.0 | 100.0 | M2422 |  <table border="1" style="margin: auto;"> <tr><th>a</th><th>b</th><th>c</th><th>R</th><th>Shoe Only No.</th></tr> <tr><td>4.0</td><td>2.0</td><td>35.0</td><td>114.3</td><td>M2389</td></tr> </table>  <table border="1" style="margin: auto;"> <tr><th>a</th><th>b</th><th>c</th><th>R</th><th>Shoe Only No.</th></tr> <tr><td>4.0</td><td>2.0</td><td>35.0</td><td>114.3</td><td>M2390</td></tr> </table>  <table border="1" style="margin: auto;"> <tr><th>a</th><th>b</th><th>c</th><th>R</th><th>Shoe Only No.</th></tr> <tr><td>4.0</td><td>2.0</td><td>35.0</td><td>114.3</td><td>M2423</td></tr> </table>  <table border="1" style="margin: auto;"> <tr><th>a</th><th>b</th><th>c</th><th>R</th><th>Shoe Only No.</th></tr> <tr><td>4.0</td><td>2.0</td><td>35.0</td><td>114.3</td><td>M2424</td></tr> </table> <div style="text-align: right; border: 1px solid black; padding: 2px;">K2423</div> | a | b | c | R | Shoe Only No. | 4.0 | 2.0 | 35.0 | 114.3 | M2389 | a | b | c | R | Shoe Only No. | 4.0 | 2.0 | 35.0 | 114.3 | M2390 | a | b | c | R | Shoe Only No. | 4.0 | 2.0 | 35.0 | 114.3 | M2423 | a | b | c | R | Shoe Only No. | 4.0 | 2.0 | 35.0 | 114.3 | M2424 |
|--|-----|------|-------|---------------|---------------|-----|-----|------|-------|-------|---|---|---|---|---------------|-----|-----|------|-------|-------|---|---|---|---|---------------|-----|-----|------|-------|-------|---|---|---|---|---------------|-----|-----|------|-------|-------|--|---|---|---|---|---------------|-----|-----|------|-------|-------|---|---|---|---|---------------|-----|-----|------|-------|-------|---|---|---|---|---------------|-----|-----|------|-------|-------|---|---|---|---|---------------|-----|-----|------|-------|-------|
| a | b | c | R | Shoe Only No. | | | | | | | | | | | | | | | | | | | | | | | | | | | | | | | | | | | | | | | | | | | | | | | | | | | | | | | | | | | | | | | | | | | | | | | | | | | | | |
| 2.9 | 1.6 | 30.0 | 100.0 | M2383 | | | | | | | | | | | | | | | | | | | | | | | | | | | | | | | | | | | | | | | | | | | | | | | | | | | | | | | | | | | | | | | | | | | | | | | | | | | | | |
| a | b | c | R | Shoe Only No. | | | | | | | | | | | | | | | | | | | | | | | | | | | | | | | | | | | | | | | | | | | | | | | | | | | | | | | | | | | | | | | | | | | | | | | | | | | | | |
| 2.9 | 1.6 | 30.0 | 100.0 | M2384 | | | | | | | | | | | | | | | | | | | | | | | | | | | | | | | | | | | | | | | | | | | | | | | | | | | | | | | | | | | | | | | | | | | | | | | | | | | | | |
| a | b | c | R | Shoe Only No. | | | | | | | | | | | | | | | | | | | | | | | | | | | | | | | | | | | | | | | | | | | | | | | | | | | | | | | | | | | | | | | | | | | | | | | | | | | | | |
| 2.9 | 1.6 | 30.0 | 100.0 | M2421 | | | | | | | | | | | | | | | | | | | | | | | | | | | | | | | | | | | | | | | | | | | | | | | | | | | | | | | | | | | | | | | | | | | | | | | | | | | | | |
| a | b | c | R | Shoe Only No. | | | | | | | | | | | | | | | | | | | | | | | | | | | | | | | | | | | | | | | | | | | | | | | | | | | | | | | | | | | | | | | | | | | | | | | | | | | | | |
| 2.9 | 1.6 | 30.0 | 100.0 | M2422 | | | | | | | | | | | | | | | | | | | | | | | | | | | | | | | | | | | | | | | | | | | | | | | | | | | | | | | | | | | | | | | | | | | | | | | | | | | | | |
| a | b | c | R | Shoe Only No. | | | | | | | | | | | | | | | | | | | | | | | | | | | | | | | | | | | | | | | | | | | | | | | | | | | | | | | | | | | | | | | | | | | | | | | | | | | | | |
| 4.0 | 2.0 | 35.0 | 114.3 | M2389 | | | | | | | | | | | | | | | | | | | | | | | | | | | | | | | | | | | | | | | | | | | | | | | | | | | | | | | | | | | | | | | | | | | | | | | | | | | | | |
| a | b | c | R | Shoe Only No. | | | | | | | | | | | | | | | | | | | | | | | | | | | | | | | | | | | | | | | | | | | | | | | | | | | | | | | | | | | | | | | | | | | | | | | | | | | | | |
| 4.0 | 2.0 | 35.0 | 114.3 | M2390 | | | | | | | | | | | | | | | | | | | | | | | | | | | | | | | | | | | | | | | | | | | | | | | | | | | | | | | | | | | | | | | | | | | | | | | | | | | | | |
| a | b | c | R | Shoe Only No. | | | | | | | | | | | | | | | | | | | | | | | | | | | | | | | | | | | | | | | | | | | | | | | | | | | | | | | | | | | | | | | | | | | | | | | | | | | | | |
| 4.0 | 2.0 | 35.0 | 114.3 | M2423 | | | | | | | | | | | | | | | | | | | | | | | | | | | | | | | | | | | | | | | | | | | | | | | | | | | | | | | | | | | | | | | | | | | | | | | | | | | | | |
| a | b | c | R | Shoe Only No. | | | | | | | | | | | | | | | | | | | | | | | | | | | | | | | | | | | | | | | | | | | | | | | | | | | | | | | | | | | | | | | | | | | | | | | | | | | | | |
| 4.0 | 2.0 | 35.0 | 114.3 | M2424 | | | | | | | | | | | | | | | | | | | | | | | | | | | | | | | | | | | | | | | | | | | | | | | | | | | | | | | | | | | | | | | | | | | | | | | | | | | | | |
|  <table border="1" style="margin: auto;"> <tr><th>a</th><th>b</th><th>c</th><th>R</th><th>Shoe Only No.</th></tr> <tr><td>2.9</td><td>1.6</td><td>30.0</td><td>100.0</td><td>M2383</td></tr> </table>  <table border="1" style="margin: auto;"> <tr><th>a</th><th>b</th><th>c</th><th>R</th><th>Shoe Only No.</th></tr> <tr><td>2.9</td><td>1.6</td><td>30.0</td><td>100.0</td><td>M2384</td></tr> </table>  <table border="1" style="margin: auto;"> <tr><th>a</th><th>b</th><th>c</th><th>R</th><th>Shoe Only No.</th></tr> <tr><td>2.9</td><td>1.6</td><td>30.0</td><td>100.0</td><td>M2425</td></tr> </table>  <table border="1" style="margin: auto;"> <tr><th>a</th><th>b</th><th>c</th><th>R</th><th>Shoe Only No.</th></tr> <tr><td>2.9</td><td>1.6</td><td>30.0</td><td>100.0</td><td>M2426</td></tr> </table> <div style="text-align: right; border: 1px solid black; padding: 2px;">K2425</div> | a | b | c | R | Shoe Only No. | 2.9 | 1.6 | 30.0 | 100.0 | M2383 | a | b | c | R | Shoe Only No. | 2.9 | 1.6 | 30.0 | 100.0 | M2384 | a | b | c | R | Shoe Only No. | 2.9 | 1.6 | 30.0 | 100.0 | M2425 | a | b | c | R | Shoe Only No. | 2.9 | 1.6 | 30.0 | 100.0 | M2426 |  <table border="1" style="margin: auto;"> <tr><th>a</th><th>b</th><th>c</th><th>R</th><th>Shoe Only No.</th></tr> <tr><td>3.2</td><td>2.0</td><td>40.0</td><td>127.0</td><td>M9000</td></tr> </table>  <table border="1" style="margin: auto;"> <tr><th>a</th><th>b</th><th>c</th><th>R</th><th>Shoe Only No.</th></tr> <tr><td>3.2</td><td>2.0</td><td>40.0</td><td>127.0</td><td>M9001</td></tr> </table>  <table border="1" style="margin: auto;"> <tr><th>a</th><th>b</th><th>c</th><th>R</th><th>Shoe Only No.</th></tr> <tr><td>3.2</td><td>2.0</td><td>40.0</td><td>127.0</td><td>M9002</td></tr> </table> <div style="text-align: right; border: 1px solid black; padding: 2px;">K9000</div> | a | b | c | R | Shoe Only No. | 3.2 | 2.0 | 40.0 | 127.0 | M9000 | a | b | c | R | Shoe Only No. | 3.2 | 2.0 | 40.0 | 127.0 | M9001 | a | b | c | R | Shoe Only No. | 3.2 | 2.0 | 40.0 | 127.0 | M9002 | | | | | | | | | | |
| a | b | c | R | Shoe Only No. | | | | | | | | | | | | | | | | | | | | | | | | | | | | | | | | | | | | | | | | | | | | | | | | | | | | | | | | | | | | | | | | | | | | | | | | | | | | | |
| 2.9 | 1.6 | 30.0 | 100.0 | M2383 | | | | | | | | | | | | | | | | | | | | | | | | | | | | | | | | | | | | | | | | | | | | | | | | | | | | | | | | | | | | | | | | | | | | | | | | | | | | | |
| a | b | c | R | Shoe Only No. | | | | | | | | | | | | | | | | | | | | | | | | | | | | | | | | | | | | | | | | | | | | | | | | | | | | | | | | | | | | | | | | | | | | | | | | | | | | | |
| 2.9 | 1.6 | 30.0 | 100.0 | M2384 | | | | | | | | | | | | | | | | | | | | | | | | | | | | | | | | | | | | | | | | | | | | | | | | | | | | | | | | | | | | | | | | | | | | | | | | | | | | | |
| a | b | c | R | Shoe Only No. | | | | | | | | | | | | | | | | | | | | | | | | | | | | | | | | | | | | | | | | | | | | | | | | | | | | | | | | | | | | | | | | | | | | | | | | | | | | | |
| 2.9 | 1.6 | 30.0 | 100.0 | M2425 | | | | | | | | | | | | | | | | | | | | | | | | | | | | | | | | | | | | | | | | | | | | | | | | | | | | | | | | | | | | | | | | | | | | | | | | | | | | | |
| a | b | c | R | Shoe Only No. | | | | | | | | | | | | | | | | | | | | | | | | | | | | | | | | | | | | | | | | | | | | | | | | | | | | | | | | | | | | | | | | | | | | | | | | | | | | | |
| 2.9 | 1.6 | 30.0 | 100.0 | M2426 | | | | | | | | | | | | | | | | | | | | | | | | | | | | | | | | | | | | | | | | | | | | | | | | | | | | | | | | | | | | | | | | | | | | | | | | | | | | | |
| a | b | c | R | Shoe Only No. | | | | | | | | | | | | | | | | | | | | | | | | | | | | | | | | | | | | | | | | | | | | | | | | | | | | | | | | | | | | | | | | | | | | | | | | | | | | | |
| 3.2 | 2.0 | 40.0 | 127.0 | M9000 | | | | | | | | | | | | | | | | | | | | | | | | | | | | | | | | | | | | | | | | | | | | | | | | | | | | | | | | | | | | | | | | | | | | | | | | | | | | | |
| a | b | c | R | Shoe Only No. | | | | | | | | | | | | | | | | | | | | | | | | | | | | | | | | | | | | | | | | | | | | | | | | | | | | | | | | | | | | | | | | | | | | | | | | | | | | | |
| 3.2 | 2.0 | 40.0 | 127.0 | M9001 | | | | | | | | | | | | | | | | | | | | | | | | | | | | | | | | | | | | | | | | | | | | | | | | | | | | | | | | | | | | | | | | | | | | | | | | | | | | | |
| a | b | c | R | Shoe Only No. | | | | | | | | | | | | | | | | | | | | | | | | | | | | | | | | | | | | | | | | | | | | | | | | | | | | | | | | | | | | | | | | | | | | | | | | | | | | | |
| 3.2 | 2.0 | 40.0 | 127.0 | M9002 | | | | | | | | | | | | | | | | | | | | | | | | | | | | | | | | | | | | | | | | | | | | | | | | | | | | | | | | | | | | | | | | | | | | | | | | | | | | | |

"Valuable information"
Interchange information (Existing MK item)

| MK No. | Application | Year |
|----------|---|-----------|
| D11230MH | HYUNDAI TUCSON, IX35 <EUR> | 2013.04- |
| D11230MH | HYUNDAI TUCSON, IX35 <GEN, ME> | 2009.11- |
| D9044 | SUZUKI GRAND VITARA JB416X-4, JB419XD-4, JB424X-4 <GEN> | - |
| D9044 | SUZUKI GRAND VITARA JB419WD, JB420W, JB627W <GEN> | - |
| D9044 | SUZUKI GRAND VITARA JB419WD, JB420W, JB424W <AFC, PHL> | - |
| D9063M | CHEVROLET CAPTIVA C100 <EUR> | 2007-2010 |
| D9063M | CHEVROLET CAPTIVA C140 <EUR> | 2011 |